

USB3.0 CMOS CAMERA

ARTCAM-MI-USB3-T2 Series

INSTRUCTION BOOKLET

5.0 M Pixels	ARTCAM-500MI-USB3-T2 Series
10.0 M Pixels	ARTCAM-1000MI-USB3-T2 Series
14.0 M Pixels	ARTCAM-1400MI-USB3 -T2 Series

Contents

1. Attention	3
2. Introduction	6
3. Main Features	6
4. The Product	8
5. Connect the Camera	8
6. Specifications	9
7. External Dimensions	12
8. Spectral Sensitivity Characteristics	13
9. Recommended PC	16

1. Attention

■About this manual

1. Before using the camera, please read this manual thoroughly.
2. Please keep this manual reachable and always refer to the contents when needed.
3. Please contact us if the manual is lost or damaged. We will provide a replacement.
4. We cannot guarantee the safety of improper uses of the camera.
5. For your safety, please follow the directions of this manual.
6. All contents are subject to change.
7. Images in this manual may have been simplified to be easier comprehended.
8. Please contact us if you find any unclear points or mistakes in this manual.
9. Quoting, copying or altering some or all parts of the manual without our permission is prohibited.
10. We are not responsible for any lost or damages on your profits due to the use of our products.
11. Please understand that our oversea branches do not provide maintenance or repair services.

■About the Icons

To keep the safety of the user, other people and their properties, please pay attention to the following icons.



Warning

If the user fails to follow the instruction, serious injury or death may occur.



Caution

If the user fails to follow the instruction, physical injury on human or damages on hardware may occur.

■For Safe Use



Warning

●In following circumstances, please stop using the product and turn off the power immediately to prevent the risks of fires and electric shocks. If the product is defective, please contact us for repair or exchange. For your safety, please do not disassemble, modify or repair the camera on your own.

Please stop using the product and turn off the power immediately when :

- The product becomes smoky or gets extremely hot on the surface, or makes unusual smells or sounds.
- Foreign material or water gets into the product.
- The product falls and becomes damaged.

●Do not place the product on unstable surfaces. The product may be fallen and people may get hurt.



Caution

●Do not expose the product to steam or fumes to avoid electric shocks and fires.

●Do not leave the product in high temperature places such as inside of vehicles or under direct sunlight. High temperature may cause damages to the camera, or even cause fires.

●Do not cover the product with cloth or other materials. The product may get extremely hot and the heat may cause deformations on the parts or even cause fires.

●Please avoid dropping or shocking the product as the product may be damaged.

●Do not touch the cable with a wet hand. Such action may cause electric shocks.

●Please avoid continuously contacting the surface of the camera to your skin when the camera is being used. The surface temperature of the camera may cause burns.

■Other Notices

●Please do not use the camera under strong lights such as sun light for a long period. Also please do not expose the camera under strong lights even when the product is not being used because the sensor might be damaged.

Maintenance

● Wipe the dirt on surface with soft cloth or tissue paper. Do not use alcohol, thinner or benzene to avoid damaging the surface paints.

Electro Magnetic Interference

●The camera may interference with electronic devices such as TV and radio. Please do not place the camera next to such equipment.

■Export Control

The Government of Japan controls military sensitive goods and technologies including relevant dual-use goods and technologies.

This product is a Catch-all Control item subject to the Foreign Exchange and Foreign Trade Act and its relevant legislations. Except for exporting to the 26 white countries designated in the Cabinet Order, export licenses are required if the products are going to be used for military use or if the end user of the product is related to all kinds of military activities. If your circumstances cause the need to apply export licenses, please notify us before you place orders. Also, please notify us in advance if the end users or purposes of use change after the purchase and thus cause the need to apply export licenses.

*The 26 white countries not under the UNSC Arms Embargo :

Argentina, Australia, Austria, Belgium, Bulgaria, Canada, Czech Republic, Denmark, Finland, France, Germany, Greece, Hungary, Ireland, Italy, Luxemburg, Netherlands, New Zealand, Norway, Poland, Portugal, Spain, Sweden, Switzerland, United Kingdom, and United States

About the Japanese Security Export Controls, please refer to the webpage for Security Export Control Policy, The Ministry of Economy, Trade and Industry :

<http://www.meti.go.jp/policy/anpo/englishpage.html>

■Guarantee

To save the environment, we do not issue warranty in printed format. Instead, all records of the warranty periods, delivery dates and the customer information are well kept in our system.

For more details, please refer to the sites below :

Hardware Warranty : [http : //www.artray.us/download/artray_warranty.pdf](http://www.artray.us/download/artray_warranty.pdf)

2. Introduction

ARTCAM-MI-USB3-T2 Series is CMOS cameras designed for industrial use. Adopting USB3.0 enable direct data transfer to PC without a capture board.

3. Main Features

- High Resolution, High Frame Rate

Realize High speed of USB3.0 interface, wide range of resolutions from 5 mega pixels to 14 mega pixels.

- USB3.0 Interface

Adopt USB3.0 interface which provides a maximum transfer rate of 5 Gbps directly to PC.

- Compact and lightweight

Easy installation to various equipments.

- Varied Selection

Monochrome and NIR models are available for 5 mega and 10 mega pixels camera.

Cased cameras, board type cameras, C-Mount board type cameras are also available for your needs.

- ROI (Region Of Interest)

One major benefit of CMOS sensor is the ROI function which enables readout of designated partial images with a faster transmission speed.

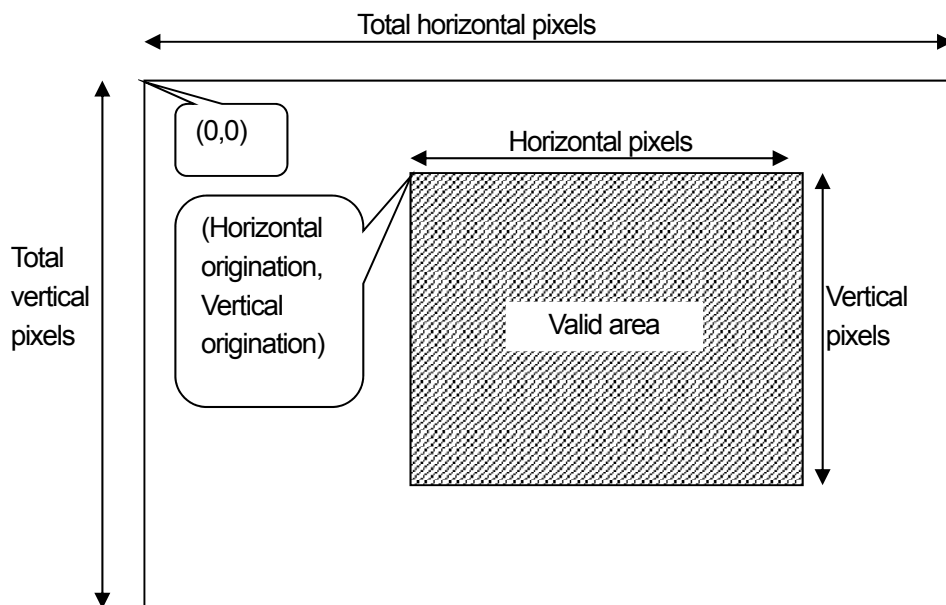

- Sub-sampling function

This function results in a more pleasing output image with reduced subsampling artifacts and improves the frame rate.

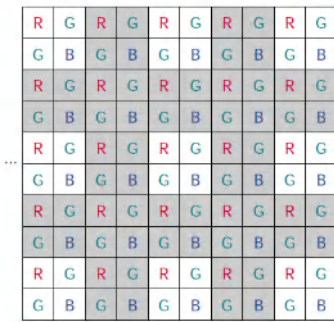

1/2 Sub-sampling mode

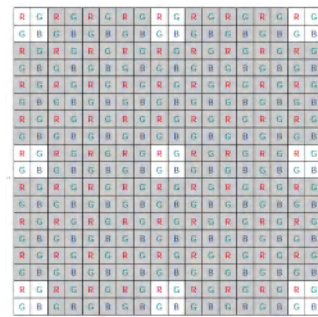

1/4 Sub-sampling mode

- Mirror function

Mirror could be processed either on the sensors or on the viewer software (ART-Viewer).

	500MI-USB3-T2	1000MI-USB3-T2	1400MI-USB3-T2
Horizontal direction	Sensor	Sensor	Software
Vertical direction	Sensor	Sensor	Software

*If mirror function is processed on software, the CPU load may become high and may cause image transfer error.

- Included Viewer Software

ART-Viewer (Windows 7/8/10).

Users can easily preview, save images and change camera settings by ART-Viewer.

- 2D Measurement & Filing Software(Optional)

Useful 2D measuring functions are available with the optional 2D Measuring & Filing Software - ART-MEASURE.

- Software Development Kit(Optional)

For customer who prefers to create their own image processing software or use our camera with other applications, we provide SDK upon requests.

4. The Product

- 1) Camera
- 2) USB3.0 Cable A to Micro B connector 3m (with locking screws)
- 3) Introduction Booklet
- 4) Viewer software/Device Driver CD

<Options>

- 1) C Mount lens
- 2) 2 Measurement & Filing Software [ART-MEASURE]
- 3) Software Development Kit [ARTCCM-SDK]

5. Connect the Camera

5-1 How to connect a camera

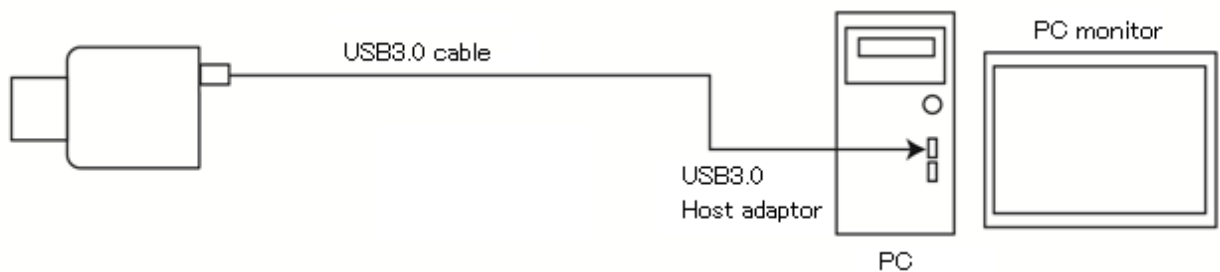

5-2 Shutter Speed

Shutter speed can be changed on the standard viewer software ART-Viewer.

The shutter speed is set directly on the sensor register, so please refer to the following formulas for the real exposure time.

Range : 1~20000(1/1000sec~2.0sec)

Exposure Time : Shutter Value*100[μsec]

※ Upper limit can be shorter depending on ROI settings.

6. Specifications

6-1 Color Model

	ARTCAM-500MI-USB3-T2	ARTCAM-1000MI-USB3-T2	ARTCAM-1400MI-USB3-T2
Sensor Type	CMOS Color Image Sensor		
Active Pixels	2592(H)×1944(V)	3856(H)×2764(V)	4068(H)×3288(V)
Active Imager Size	5.70(H)×4.28(V)mm 1/2.5"	6.41(H)×4.59(V)mm 1/2.3"	6.45(H)×4.60(V)mm 1/2.3"
Scan Mode	Progressive Scan		
Pixel Size	2.2(H)×2.2(V)μm	1.67(H)×1.67(V)μm	1.4(H)×1.4(V)μm
Shutter Type	Rolling Shutter		
Color Filter Array	RGB Bayer Pattern		
Frame Rate	13.9fps	6fps	6fps
Shutter Speed	1/10000 ~ 2.0s	1/10000 ~ 2.0s	1/10000 ~ 2.0s
Interface	USB3.0 Bulk Transfer		
Synchronization System	Internal Synchronization		
Lens Mount	C Mount		
Power	DC5V(Supplied by USB port)		
Power Consumption	Under Approx.4W		
Ambient Conditions	Operating Temperature/Humidity : 0 ~ 35°C / 10 ~ 80%(Non condensing) Storage Temperature/Humidity : 0 ~ 60°C / 10 ~ 95%(Non condensing)		
External Dimensions	50.0(W)×47.0(H)×42.7(D)mm *Lens, tripod mount is not included	50.0(W)×47.0(H)×42.7(D)mm * Lens, tripod mount is not included	50.0(W)×47.0(H)×42.7(D)mm * Lens, tripod mount is not included
Weight	Approx. 150g	Approx. 150g	Approx. 150g

6-2 Monochrome Model

	ARTCAM-500MI-BW-USB3-T2	ARTCAM-1000MI-BW-USB3-T2
Sensor Type	CMOS Monochrome Image Sensor	
Active Pixels	2592(H)×1944(V)	3856(H)×2764(V)
Active Imager Size	5.70(H)×4.28(V)mm 1/2.5"	6.41(H)×4.59(V)mm 1/2.3"
Scan Mode	Progressive Scan	
Pixel Size	2.2(H)×2.2(V)μm	1.67(H)×1.67(V)μm
Shutter Type	Rolling Shutter	
Frame Rate	13.9fps	6fps
Shutter Speed	1/10000~2.0s	1/10000~2.0s
Interface	USB3.0 Bulk Transfer	
Synchronization System	Internal Synchronization	
Lens Mount	C Mount	
Power	DC5V(Supplied by USB port)	
Power Consumption	Under Approx.4W	
Ambient Conditions	Operating Temperature/Humidity : 0 ~ 35°C / 10 ~ 80%(Non condensing) Storage Temperature/Humidity : 0 ~ 60°C / 10 ~ 95%(Non condensing)	
External Dimensions	50.0(W)×47.0(H)×42.7(D)mm *Lens, tripod mount is not included	50.0(W)×47.0(H)×42.7(D)mm * Lens, tripod mount is not included
Weight	Approx.150g	Approx.150g

6-3 NIR model

	ARTCAM-500MI-NIR-USB3-T2	ARTCAM-1000MI-NIR-USB3-T2
Sensor Type	CMOS Monochrome Image Sensor	
Active Pixels	2592(H)×1944(V)	3856(H)×2764(V)
Active Imager Size	5.70(H)×4.28(V)mm 1/2.5"	6.41(H)×4.59(V)mm 1/2.3"
Scan Mode	Progressive Scan	
Pixel Size	2.2(H)×2.2(V)μm	1.67(H)×1.67(V)μm
Shutter Type	Rolling Shutter	
Frame Rate	13.9fps	6fps
Shutter Speed	1/10000~2.0s	1/10000~2.0s
Interface	USB3.0 Bulk Transfer	
Synchronization System	Internal Synchronization	
Lens Mount	C Mount	
Power	DC5V(Supplied by USB port)	
Power Consumption	Under Approx.4W	
Ambient Conditions	Operating Temperature/Humidity : 0 ~ 35°C /10 ~ 80%(Non condensing) Storage Temperature/Humidity : 0 ~ 60°C /10 ~ 95%(Non condensing)	
External Dimensions	50.0(W)×47.0(H)×42.7(D)mm *Lens, tripod mount is not included	50.0(W)×47.0(H)×42.7(D)mm * Lens, tripod mount is not included
Weight	Approx.150g	Approx.150g

7. External Dimensions

7-1 C-MOUNT, CASED CAMERA

ARTCAM-500MI-USB3-T2/ 500MI-BW-USB3-T2 / 500MI-NIR-USB3-T2

ARTCAM-1000MI-USB3-T2/ 1000MI-BW-USB3-T2/ 1000MI-NIR-USB3-T2

ARTCAM-1400MI-USB3-T2

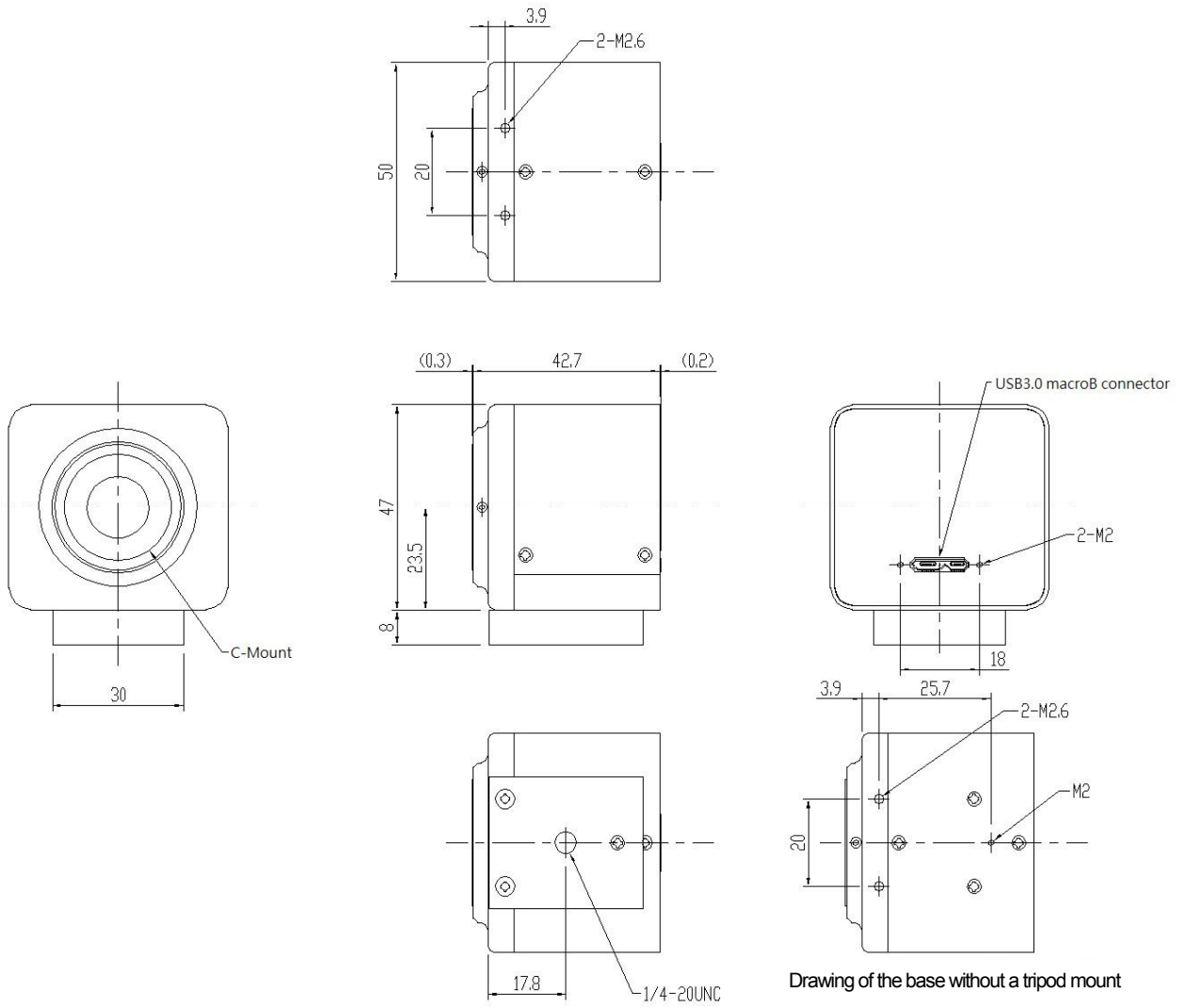

8. Spectral sensitivity characteristics

8.1 ARTCAM-500MI-USB3-T2 series(Color Model)

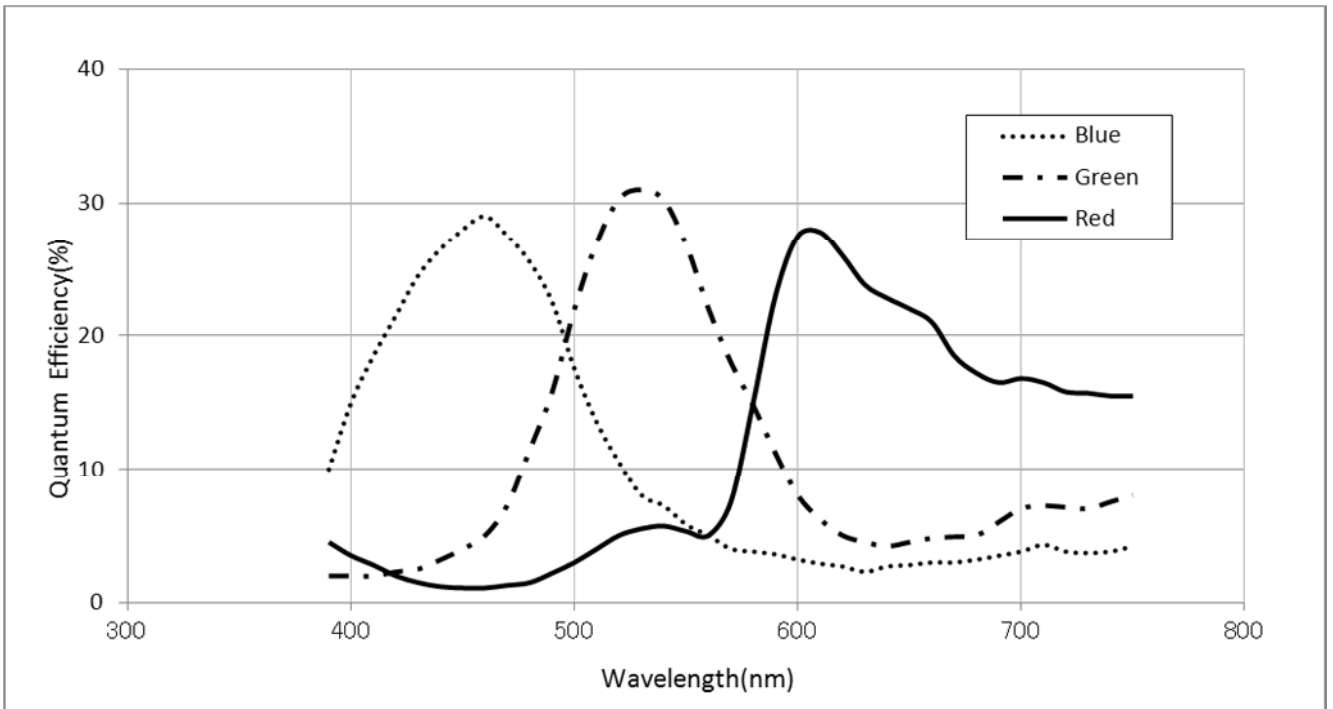

8.2 ARTCAM-500MI-BW-USB3-T2 series(Monochrome Model)

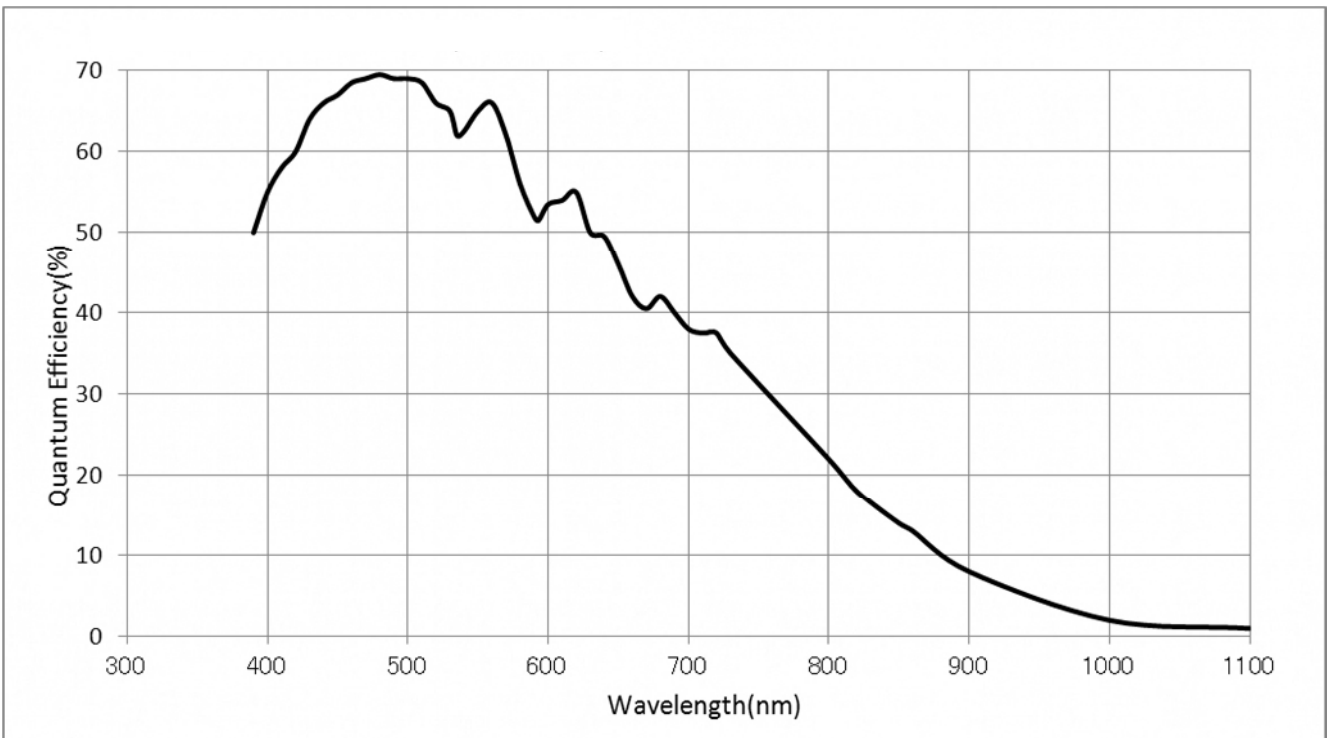

8.3 ARTCAM-1000MI-USB3-T2 series(Color Model)

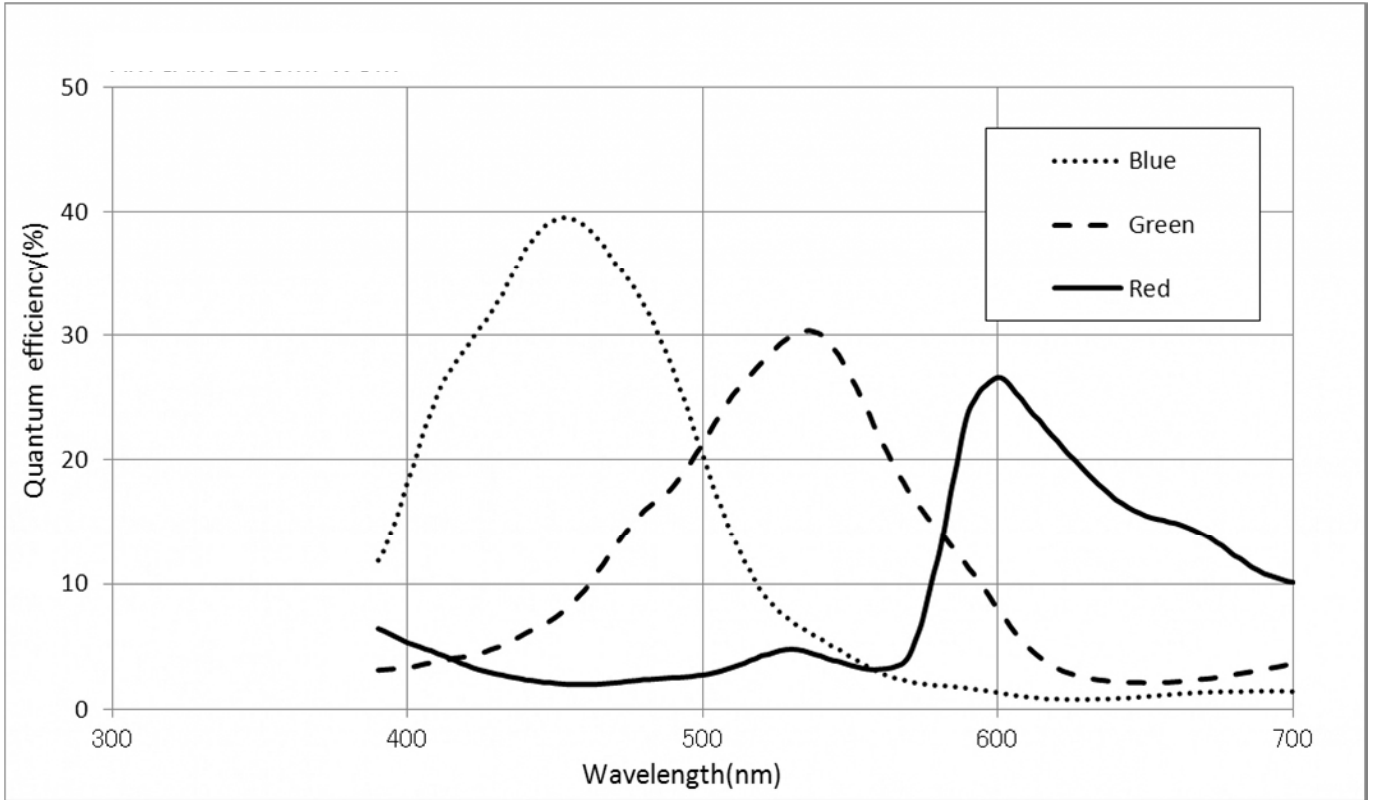

8.4 ARTCAM-1000MI-BW-USB3-T2 series(Monochrome Model)

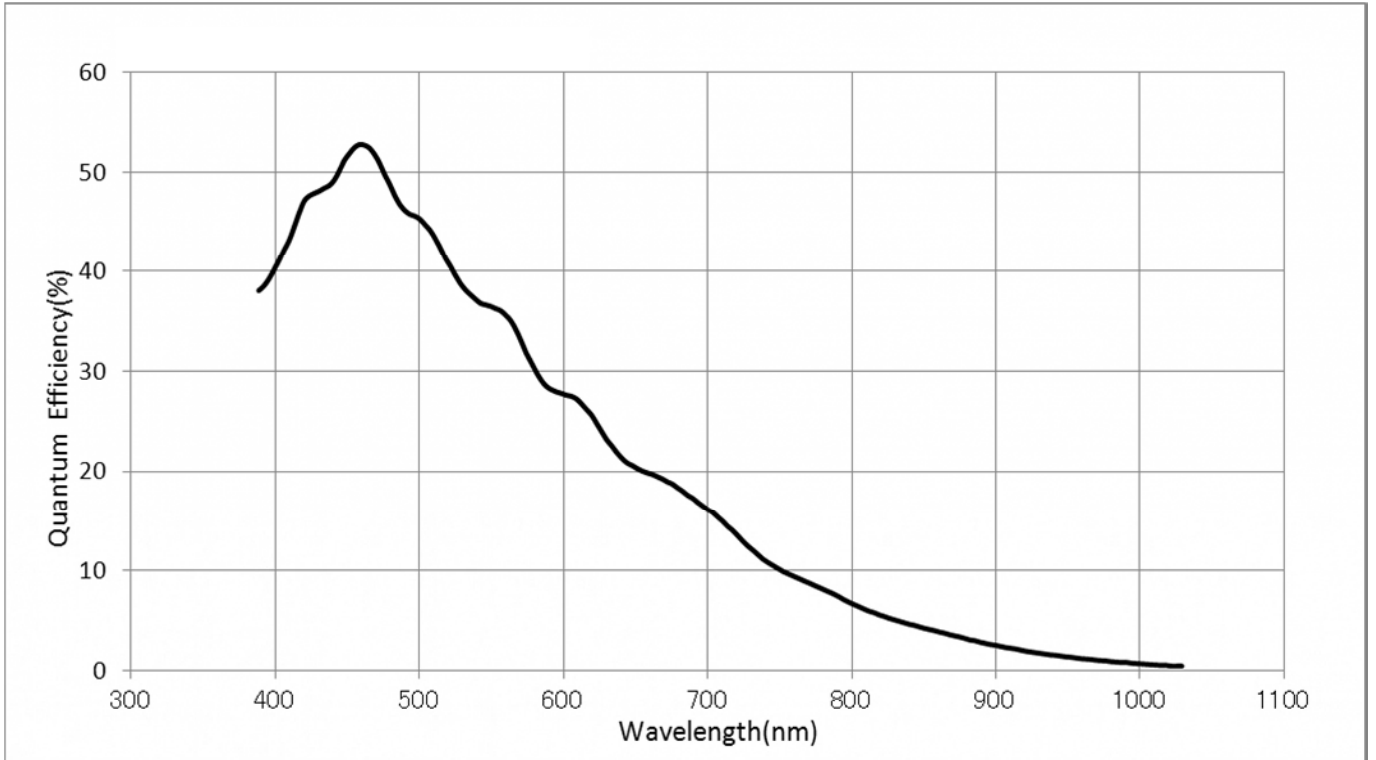

8.5 ARTCAM-1400MI-USB3-T2 series(Color Model)

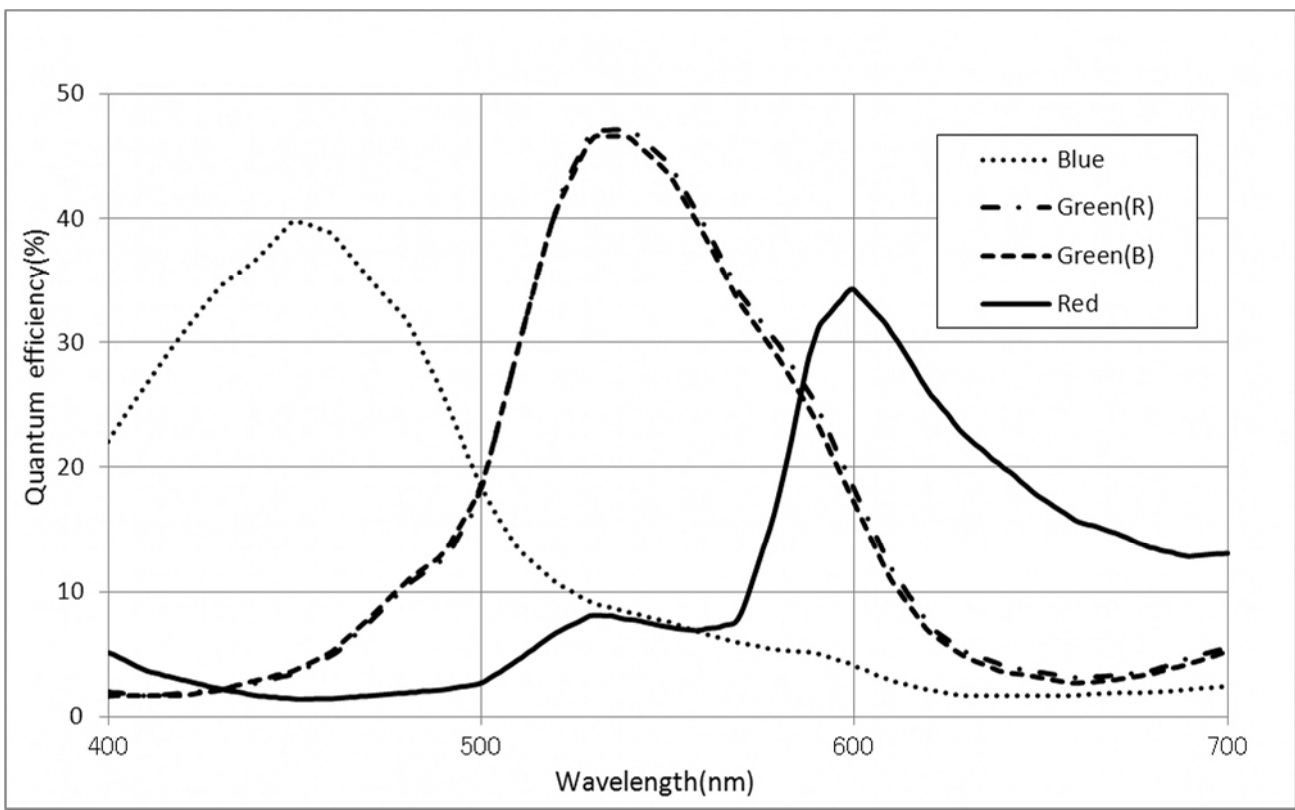

9. Recommended PC Spec

9-1 System Requirements

●Host Controller

This camera is applicable to USB 3.0.

Connecting to USB 2.0 host controller may cause low-speed or failure to function properly.

●CPU

The driver of this camera is applicable to computer architecture "x86" or "amd64".

The specification of CPU effects directly the imaging process speed, therefore it is highly recommended to utilize a high-end CPU if possible.

●Memory

In the viewer software, there is a data buffer which can store 4 to 8 frames.

Therefore, it is necessary to keep spare space at least for 8 frames in the memory.

(For example, when using 1.3MP color camera, $1280 \times 1024 \times 3 \times 8$ [byte] = 30[MB] is necessary.)

It is highly recommended to keep enough memory space especially when using high resolution camera.

●OS

This camera is applicable only to the architecture of Windows NT (32bit/64bit).

Standard functions are confirmed with OS after Windows.

In addition, it is recommended to use Windows 10.



Caution

■Please refer the restrictions below when you use ARTCAM series.

(1) Recommended System Requirements

If the system specifications do not meet the requirements recommended above, it may be difficult to run at the maximum frame rate.

(2) Use of other USB3.0 Hardware

The data on our camera/converter is transferred in bulk mode. For this reason, when using our camera/converter, please avoid using other bulk transferred USB3.0 hardware such as Memory stick, External HDD, External DVD, CDROM etc.

As a solution, we recommend installing a PCI USB host card to the PC and connect external USB hardware to this port only.

(3) USB3.0 Cable Extension

We cannot guarantee the functionality of the USB3.0 camera if the user adopts USB3.0 extension cables or repeaters which are not confirmed by us. With the extension cables or repeaters, the bandwidth of transfer may differ, and thus caused malfunctions such as a low frame rate or recognition failure on the camera.

What may cause the problem is that the regulation of the power lines becomes not enough, and so causes impedance mismatch on data signals.

*For the recommended extension cable, please contact our sales department.

(TEL: +81-3389-5488)

ARTRAY CO., LTD. Obtained ISO 9001: 2015 2018/9/17

1-17-5 Kouenjikita, Sugunami-ku, Tokyo 166-0002 Japan

Tel : +81-3-3389-5488 Fax : +81-3-3389-5486

Email : sales@artray.us URL : www.artray.us